

# MD150E Instruction Manual

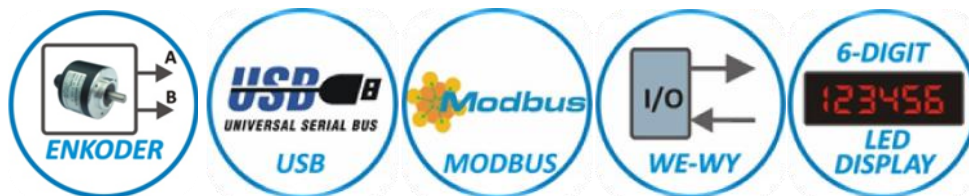

**Digital processing counter with display  
for angle, velocity and distance measurement**



[www.wobit.com.pl](http://www.wobit.com.pl)

P.P.H. WOBIT E.K.J OBER. s.c.  
62-045 Pniewy, Dęborzyce 16  
tel.(061) 22 27 422, fax.(061) 22 27 439  
e-mail: [wobit@wobit.com.pl](mailto:wobit@wobit.com.pl)  
[www.wobit.com.pl](http://www.wobit.com.pl)

# Contains

1.	Safety and assembly rules .....	3
2.	Device description .....	4
2.1	Intended use and properties .....	4
2.2	Description of connectors and front panel.....	4
2.3	Power supply .....	5
2.4	Compatible devices .....	5
2.5	Input signals – way of connection .....	6
2.6	Counter indications – pulses / cycles / velocity .....	7
3.	Menu description .....	8
3.1	MENU map .....	8
3.2	Example of parameter change .....	9
4.	Counter configuration .....	9
4.1	Inputs modes – Encoder / Up-Down / Step-Direction .....	9
4.2	Calibration of counted pulses .....	11
4.3	Measurement of pulses frequency (velocity) .....	11
4.4	Filtration of input signals .....	11
4.5	Resetting of pulses and cycles counter .....	11
4.6	Record of counter state .....	12
4.7	Relay outputs and operation modes .....	12
5.	Password protection .....	14
6.	USB and RS485 Modbus interfaces.....	14
6.1	USB interface.....	14
6.2	RS485 (MODBUS-RTU) interface .....	14
6.2.1	Description of MODBUS protocol .....	15
7.	Technical parameters .....	16

Thank you for selecting our product!

This instruction will help you at correct service and accurate exploitation of described device.

Information included in this instruction were prepared with high attention by our specialists and is description of the product without any responsibilities within the meaning of the commercial law. Based on the information should not be inferred a certain features or suitability for a particular application. This information does not release the user from the obligation of own judgment and verification. P.P.H. WObit E.K.J. Ober S.C. reserves the right to make changes without prior notice.

- Please read instructions below carefully and adhere to its recommendation
- Please pay special attention to the following characters:



### CAUTION!

Not adhere to instruction can cause damage or impede the use of hardware or software.

# 1. Safety and assembly rules

## Safety rules

- Prior to first start-up of the device carefully read the manual.
- Prior to first start-up of the device make sure all cables are properly connected.
- Provide appropriate working conditions, in compliance with the device specifications (e.g.: power supply voltage, temperature, maximum current consumption).
- Prior to any modifications of cables connections, disconnect power supply voltage.
- Dismantling of the indicator housing during guarantee agreement period results in its invalidation.

## Assembly recommendation

In the environments of unknown levels of interruptions it is recommended to use the following means preventing against possible interruptions of the device operation:

- Ground or zero the metal rails on which instruments are mounted.
- Do not power the device from the same lines as high power devices without appropriate network filters.
- Apply power supply, sensor and signal cables screening while screen grounding should be connected only on one side as close to the device as possible.
- Use communication cables (USB) equipped with filters in the form of ferrite beads.
- Avoid routing control (signal) cables in parallel with or in close vicinity of power and supply cables.
- Avoid close vicinity of devices generating high level of electromagnetic and/or pulse interference (high power loads, loads with phase or group power regulation).

## 2. Device description

### 2.1 Intended use and properties

**MD150E** is a multipurpose, programmable counter designed for counting pulses from incremental encoder or other sources of square wave signals. MD150E can define signal frequency and scale counted values into required unites (rpm, rps, mm, m, deg, etc.)

With two relay outputs the user is able to set thresholds as desired. MD150E is also equipped with additional input for resetting counter state.

**MD150E** counter is very intuitive. Only one parameter is needed to scale number of counted pulses to required unit.

MD150E is equipped in **USB** and **RS485 MODBUS** interfaces. USB enables direct connection between processing unit and PC (record to csv file). RS485 interface with MODBUS-RTU protocol enables communication with industrial devices like PLC or HMI.

Housing made of full aluminum profile guarantees excellent mechanical resistance to harsh external conditions.

#### MD150E features:

- Counting external pulses with frequency up to **2Mhz**,
- Power supply 12...36V DC or 230V AC (depends on version)
- Can cooperate with any incremental encoder, linear magnetic encoder, other sources of Step/direction signals etc.,
- Scale of counting pulses to any unites,
- Defining frequency of counted pulses,
- Possibility of recording counted pulses – reconstructing counter state after turning on the device,
- Setting status of relay outputs based on set thresholds,
- 4 operation modes of relay outputs + additional **cycle counter** - it allows use in dose application without additional controller,
- Data transmission to PC (**USB**) or master device e.g. HMI panel, PLC (**RS485 MODBUS-RTU**).

### 2.2 Description of connectors and front panel

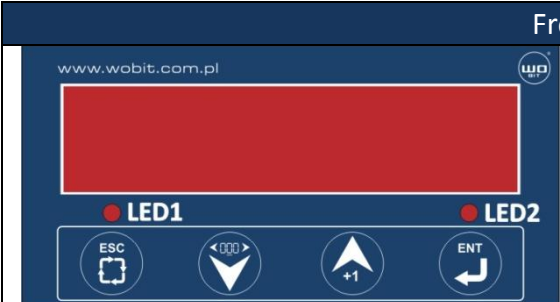
Front panel	
	<b>LED1</b> - indicator of PK1 relay activation
	<b>LED2</b> - indicator of PK2 relay activation
	<b>ESC</b> - abortion, Reset (>3sec.)
	<b>DOWN</b> - next menu position/next parameter digit/ change of displaying mode
	<b>UP</b> - previous menu position / digit value increase / change of displaying mode

	<b>ENTER</b>	- menu entry/confirmation of entered changes	
<b>Back panel</b>			
	1	RST	Resetting input
	2	B+	B+ counter input
	3	B-	B- counter input
	4	A+	A+ counter input
	5	A-	A- counter input
	6	+5V	Output +5V for sensor, max 500mA
	7	485A	A signal of RS485 interface
	8	485B	B signal of RS485 interface
	9,10	PK1	PK1 (NO) relay contacts
	11,12	PK2	PK2 (NO) relay contacts
	13	V+	12-36VDC power supply (or +15V output for ~230V power supply option)
	14	GND	Ground
	15,16	230V	Power supply 230V AC (230V version)
	17	PE	Protective signal (230V version)

## 2.3 Power supply

MD150E counter is available in two versions of power supply – low voltage (12...36 VDC) and high voltage ( 85...260V AC) supplied directly from mains electricity ~230V. For ~230V version on 13 (V+) clamp is available +15V voltage, which can be used for supplying sensor.

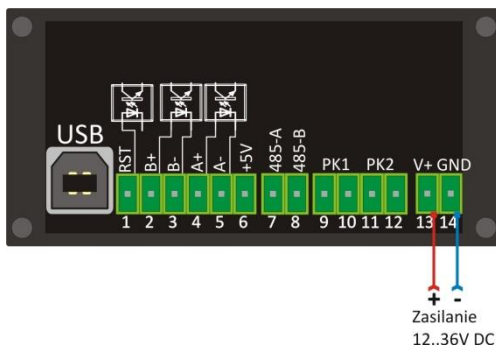

12..36V DC Power supply

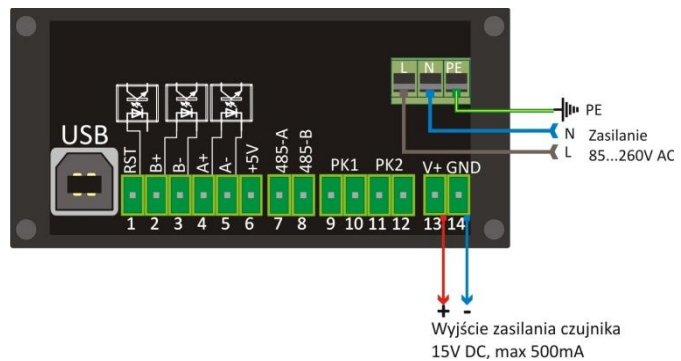

85..260V AC Power supply



### Caution!

For ~230V supply version, before any connections you should disconnect the device from main electricity.

## 2.4 Compatible devices

MD150E counter is designed for integration with optical encoders with square wave output. That transducers are available in wide range of resolutions, versions of electronics, with connector or cable. MD150E can be also integrate with magnetic linear encoders to measure linear displacement; with motor drivers which generates Step/Direction signal or to count pulses from inductive sensors etc.

## Encoders



Incremental encoders are designed for angle displacement measurement, which means measurement of angle, number of rotation and angle velocity. Using belt drive, cog wheel or friction wheel it is possible to measure linear displacement.

Encoder allow to define position by counting pulses. It can also recognize direction of movement due to phase shift of A and B channel (square wave signal). Some encoders have C zero channel, which by each rotation indicates an absolute position. It can be used for designation of zero position.



### Linear magnetic encoders

Linear encoders are designed for direct measurement of linear displacement. Incremental length measuring system consisting of read head and magnetic tape. An example of sensor is **GC-MK2** or **GC-MK5** from WObit's offer.

## Proximity sensors, Area sensors



All sensors with output signal NPN or PNP can be connected directly to MD150E counter to count number of this signals. For example this sensors can be used for counting numbers of elements on a production line or for defining numbers of rotation/ velocity of measuring wheel.

## CLOCK/DIRECTION signals for controlling servomotors and stepper motor drivers

For controlling servomotors and stepper motor drivers often are used CLOCK/DIR signals. This signal can be connected directly to MD150E counter, then it can be used for direct indication of motor position/velocity.

## 2.5 Input signals – way of connection

MD150E counts pulses from **two opt insulated A and B input channels** + zeroing signal (RST). This signals can be given asymmetrically (input + or – connected to sensor's ground) as well as symmetrically (straight signal and negation + and - inputs simultaneously). Most of rotary and linear encoders give asymmetrical signal (differential) due to greater transmission resistance for industrial noise. Simple proximity sensors usually give straight signal (without negation).

Level of transducers input signal depend on electronic standard. The most popular is O.C. (voltage supply +24 V, +12 or +5 V). This standard can't be used for long distances with high signal frequency. At distances up to 100 m and high rotational velocity of transducer usually is used Line Driver standard (RS422). At this standard at transducer are available also A and B signal negations. Then should be used proper cable with correct impedance (signal send in pairs, e.g. A+/A-).

**MD150E has fully opt insulated differential counter inputs, on which can be given signals in range 5..24V (between „+” and „-” clamp). It can be integrated directly with most of sensors (supplied from +5V as well as +24V).**

Owing to input signal on opt-isolator is internally formed in square course with proper slope (for correct pulse identification). As pulse generator can be used almost any element with slow increasing pulse like optical sensor or proximity sensor. In case of electromechanical pulse sources, **the**

condition of correct operation is the elimination of joint vibration effect, causing pulse multiplication.

Way of connection external signals to MD150E counter depends on used sensor output type. Below are shown exemplary ways of connection.

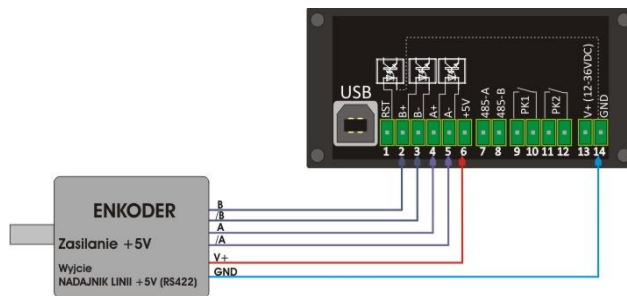

Picture. 1 Connection of +5V encoder with output RS422 type (Line driver).

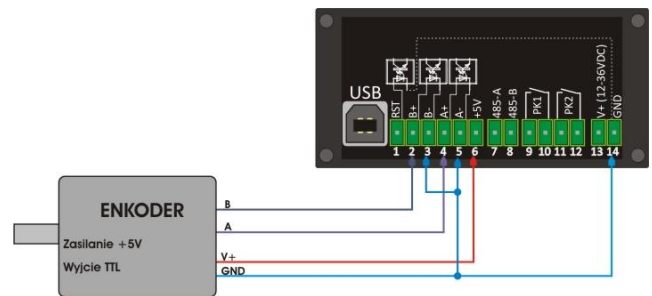

Picture. 2 Connection of +5V encoder with output TTL type.

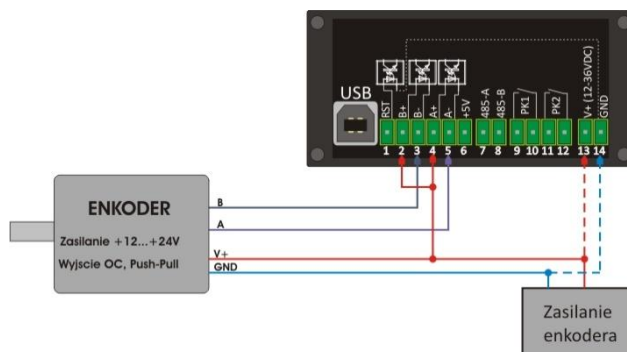

Picture. 3 Connection of +12V..+24V encoder with output Open Collector (OC) or Push-Pull (PP) type.

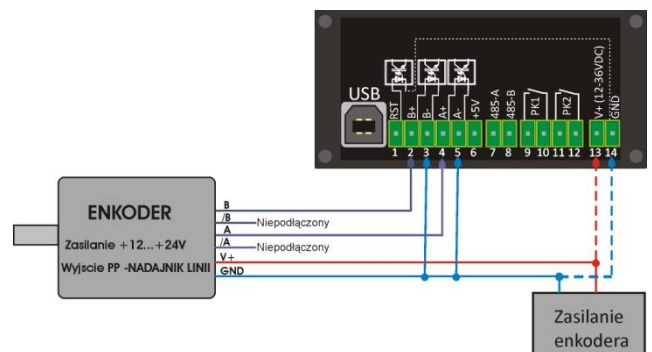

Picture. 4 Connection of +12V..+24V encoder with output Push-Pull and Line Driver type.

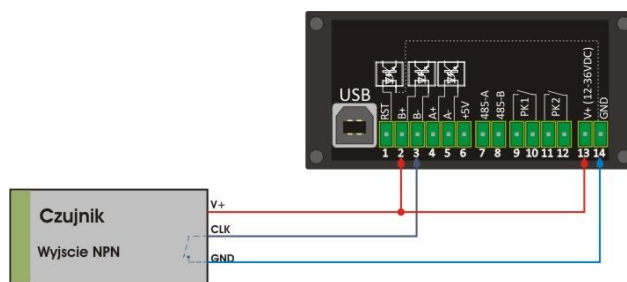

Picture. 5 Connection of sensor with NPN output.

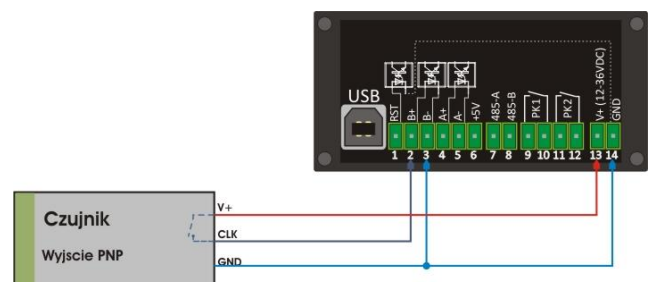

Picture. 5 Connection of sensor with PNP output.

## 2.6 Counter indications – pulses / cycles / velocity

MD150E can display one of three measuring values:

- Value of pulses counter
- Value of cycle counter– value is preceded by L
- Pulses frequency (velocity) – value is preceded by U













You can switch between next values apart from the MENU, using UP/DOWN buttons.

There is an additional option to set default counter indications after its activation (MENU-> 11. DISP).

Value of pulses counter = counted pulses/calculator (**DIV** parameter) + offset (**OFFS** parameter)  
 Value of cycle counter = pulses counter / P1 setting (only at 0 and 3 operation modes)

## 3. Menu description

### 3.1 MENU map



000000 -> displaying of current measurement value				
 Menu entry ↓		  Change of displayed value: <ul style="list-style-type: none"> <li>▪ No sign: Pulses</li> <li>▪ <b>U</b> sign: velocity</li> <li>▪ <b>L</b> sign: cycles</li> </ul>		 (>3 sec.) Reset of pulses and cycles counter
1. P1 -> Menu				
  Next/previous parameter		 parameter selection		 Digit selection  Change value Parameter edition
1.	P1	Settings control relays	Relays	± 999999
2.	P2	Settings control relays		± 999999
3.	PTIM	Time of relays activation (depends on PMOD)		0...999999 ms
4.	PMOD	Relays operations mode		mode 0 / 1 / 2 / 3 / 4
5.	DIV	Pulses calculator (divider) into required unit	Measurement	± 9999.99
6.	OFFS	Offset of initial counter value		± 999999
7.	IN	Signal input mode of counter		A-b / U-d / d-C
8.	FILT	Filtration of input signals		on / oFF
9.	DP	Number of decimals of the result		0...5
10.	SPD	Unit of velocity counter		1.Sek / 2. Min /3. Hour
11.	DISP	Default indications of the counter after its activation		PoS / SPEEd / CYCLE
12.	MEM	Record of counter position	on / oFF	
13.	CLR	Counter zeroing mode	oFF / riS / FAL	
14.	RS1	MODBUS address	RS485	0-99
15.	RS2	MODBUS baudrate		96000 / 19200 / 38400 57600 / 115200
16.	BEP	Sound signal of buttons	Other	On / oFF
17.	LED	Brightness level of display		0-9
18.	FAC	Restoring factory default settings		
19.	PAS	Password		X-0000 - non active
 Menu exit/abortion		   Parameter confirmation/abortion		











**CAUTION:** Appearing of blinking measured value on display preceded by C means overflowing of result value (the result don't fit in 6 position display). To display older part of the result press  button.





## 3.2 Example of parameter change

After correct connection of external elements and switching power supply on MD150E counter is ready for operation with previously used settings, and in case of first operation – with factory settings.

In order to enter programming mode, press . The display shows **1. P1**, if the password is switched off or **0000** if it is active. In such case, in order to enter programming mode (at active password) enter the password and confirm it with the key ;

- With subsequent pressing of  key you switch to next parameters and with pressing of  key you return to previous parameters.
- At the selected parameter you want to change, press ;
- With  key select display digit position you want to change and change its value with  key. Confirm the entered value with  key;
- Value of single digit parameters is selected with  and  keys;
- If you want to enter a negative value select the first digit (from the left) then press and hold  key until the symbol “-” is displayed.
- With  key you confirm the introduced change and with  key you abort the change or exit the menu.

Prolonged pressing of  or  keys results in automatic increase/decrease of a given position/value.

## 4. Counter configuration

### 4.1 Inputs modes – Encoder / Up-Down / Step-Direction

Selection of input signal sources depends on application. User can use two differential input channels: A+/A- and B+/B- used for counting and RST signal for counter zeroing. One of three ways of signals interpretation is specified as **Input mode** parameter – **7. In**, which enables setting modes presented below:

#### A-B – encoder

A-B mode is designed for use with encoders, which generate signals on two channels shifted in phase. It enables to define direction of movement, and counting of all 4 slopes (square wave) allows to increase four times the real encoder resolution.

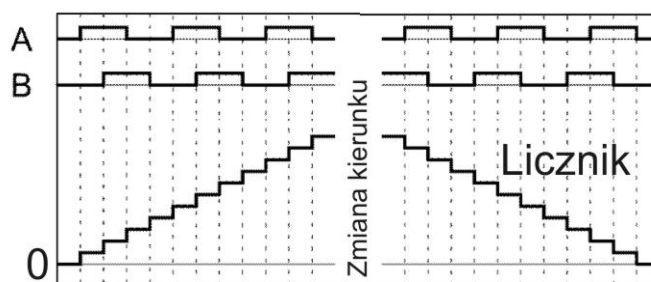

## U-D – up/down

At this mode pulses given on B channel increase counter value and given on A channel decrease counter value. **You can't use this mode for encoders.** This mode requires signals from two independent sources.

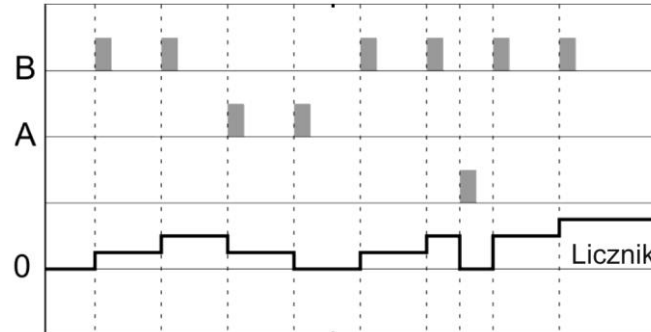

## D-C – Direction/Clock

d-C mode is specific to control of stepper motors and servo motors. B channel counts pulses, A channel switch counting direction. This mode is designed mostly for use with external devices or with sensors with mentioned above signals.

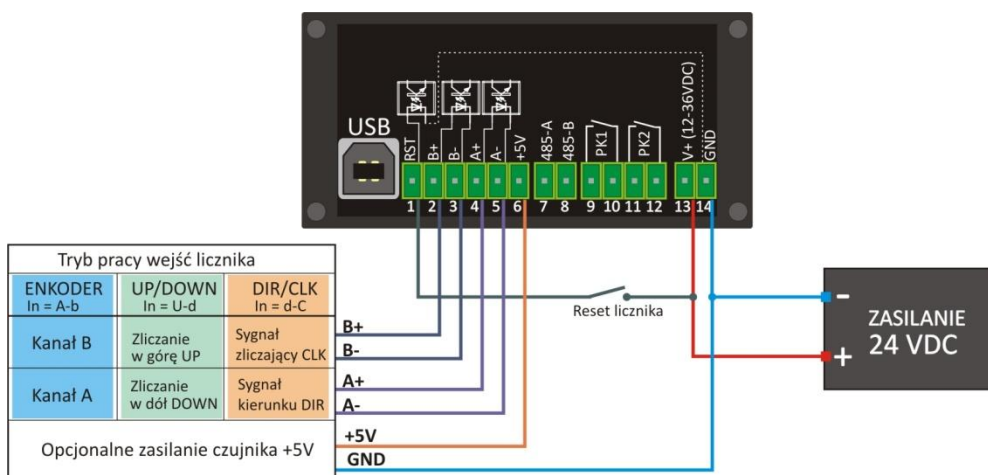
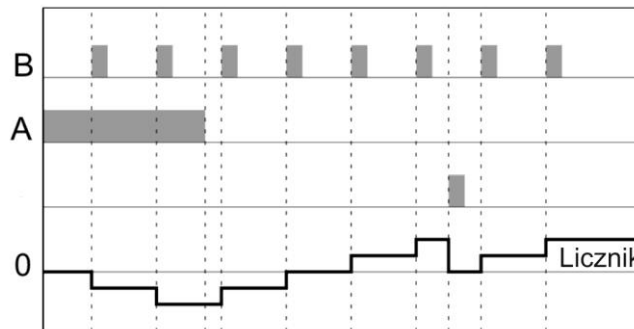

Picture. 6 Meaning of A/B external signals in dependence on input mode (7. In parameter).

## 4.2 Calibration of counted pulses

5. **DIV** parameter allows conversion of received pulses into selected unit e.g. distance or rpm.

### Other parameters which influence on displayed value

6. **OFFS** – value offset causing adding for indication constant number value,

9. **DP** – allows to define number of decimals of displayed result. DP parameter also influence on range of 1. **P1**, 2. **P2** and 6. **OFFS** parameters. If **DP** = 0, then **P1**, **P2**, **OFFS** settings can be changed only in an integer part in range from -99999 up to 999999. When **DP**=4 parameters above could be changed in range from -99.9999 up to 99.9999.

## 4.3 Measurement of pulses frequency (velocity)

MD150E counter provides readout of counted pulses frequency, which allows e.g. to define rotational or linear speed of measured object with build-in sensor generating pulses. To provide correct velocity indication in set units (e.g. in mm/sec., rpm./sec.) you should properly calibrate pulses according to 4.2 paragraph.

Furthermore 10. **SPD** parameter allows to define unit of displayed velocity in:

1. SEH –pulses / second (gate time 0,1 sec.)
2. nIn – pulses / minute (gate time 1 sec.)
3. HoUr – pulses / hour (gate time 60 sec.)



### CAUTION!

During external zeroing of the counter (or counter operation mode with automatic zeroing), when zeroing occur more often than gate time of velocity measurement, the velocity won't be updated.

## 4.4 Filtration of input signals

8. **FILT** parameter provides activation of filtration for **A**, **B** counting signals and reset signal **RST**. Filtration prevents accidental counting of pulses (or counter reset by RST input) during operation in noise environment or while counting of pulses from irregular slopes.

	Filtration deactivated -> <b>FILT = OFF</b>	Filtration activated -> <b>FILT= ON</b>
<b>A/B Inputs</b>	Inputs frequency. max. 2Mhz	Inputs frequency. max. 125Khz
<b>RST Input</b>	Resetting pulse > 1mS	Resetting pulse > 10ms

Table 1. Inputs parameters in dependence on set filtration.

## 4.5 Resetting of pulses and cycles counter

**Reset by keyboard** : Press and hold  (ESC) button by 3 sec. On display appears **Reset** inscription.

**Reset by external signal RST**: State of pulses and cycles counter can be reset by signal given on resetting input RST. There is an additional possibility to set signal slope, on which should occur counter reset or blocking of external reset function. For this aim is designed 13. **CLR** parameter, which can take values listed below:

1. **oFF** - external reset turned off

2. **rIS** - reset on rising slope (signal change from 0 to +5..+24V)
3. **FAL** - reset on falling slope (signal change from +5..+24V to 0V)

## 4.6 Record of counter state

MD150E provides saving of current pulse counter state which is accessible after next counter activation. For this purpose use **12. MEM** parameter. When that parameter is set on „On” the current value of the counter will be saved before its turning off and will appear on display after next turning on.



### CAUTION!

Cycle counter state (L) is not saved.

## 4.7 Relay outputs and operation modes

MD150E counter has two relay outputs PK1 and PK2, which can be turned on/off in dependence on counter state and operation mode. For configuration relay outputs you can use parameters listed below:

1. **P1** - P1 setting
2. **P2** - P2 setting
3. **PTIM** - relay turn-on duration (in milliseconds)
4. **PMOD** – operation mode



### CAUTION!

P1 and P2 settings can take negative values, but it is useful only in some cases (see -> operation modes)

**PMOD** operation mode defines way of turning on/off of relay outputs, automatic counter reset at specified value and increasing of cycle counter. There are available operation modes listed below:

#### ➤ **Mode 0 (node 0)** – Cyclic mode with automatic reset

At this mode reset of the counter occur after reaching **P1** setting. Each zeroing of the counter also causes increasing cycle counter (L). At the same time **PK1** follows into active state for time specified by **PTIM** parameter, or for non defined time when **PTIM** = 0.

If **P1 > P2** condition is fulfilled, **PK2** output will be active in range of **P1 ÷ P2** indications. In other condition **PK2** stayed off-line.

**P1 > P2**  
**PTIM > 0**

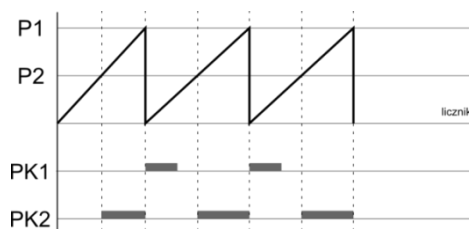

**PK1 output** activates **PTIM** time, while counter will exceed value of **P1** setting. At the same time pulses counter is reset and cycle counter increases (L).

**PK2 output** will be activated when counter value will be located between **P1** and **P2** settings.

➤ **Mode 1 (node 1)** – Absolute with two thresholds

Activation of **PK1** and **PK2** outputs occurs after reaching **P1** and **P2** values, which can be positive or negative.

➤ **Mode 2 (node 2)** – Absolute with thresholds and margin

At this mode **PK1** output is active when counter value is in range  $(P2 - P1) \div (P2 + P1)$ . If **P2** < 0, **PK2** output will be active after reaching **P1** setting (positive or negative).

➤ **Mode 3 (node 3)** – Cyclic with cycle counting

At this mode counter reset occur after reaching **P1** setting. At the same time **PK1** output follows into active state for time specified by **PTIM** parameter for non defined time when **PTIM** = 0. Each zeroing is counted by cycle counter (**L**). If cycle counter (number of zeroing of pulses counter) reach value set by **P2** parameter, **PK2** output will be activated.

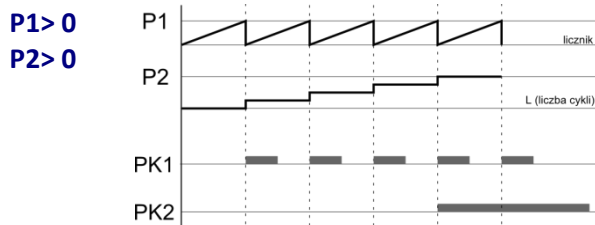

**PK1 output** is activated for **PTIM** time when counter will reach **P1** value. At the same time pulses counter is reset and cycles counter increases (**L**).

**PK2 output** is activated when cycles counter reach **P2** value and it is turned off when counter is reset by external signal or by keyboard.

This mode is dedicated for application in cutting machines for counting length and number of cut elements.

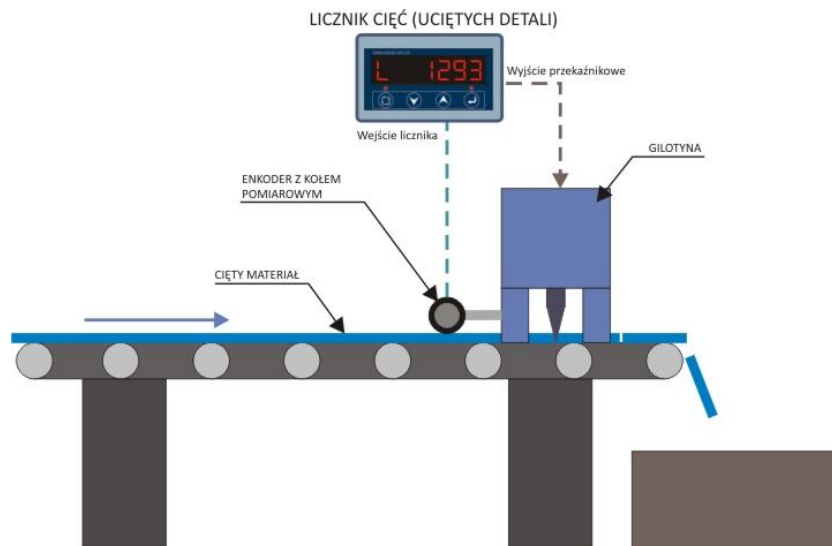

Picture. 7 Example of length measurement application with MD150E used for counting material cut offs in a production line.

➤ **Mode 4 (node 4)** – Absolute controlled by velocity

Activation of **PK1** and **PK2** outputs follows when velocity counter exceed (pulses frequency) values of **P1** and **P2** settings.

## 5. Password protection

Access to the process display settings can be password protected (parameter **19. PAS**). There are 3 protection levels available. Protection level is set with the first digit, and the last 4 digits are used for password entry.

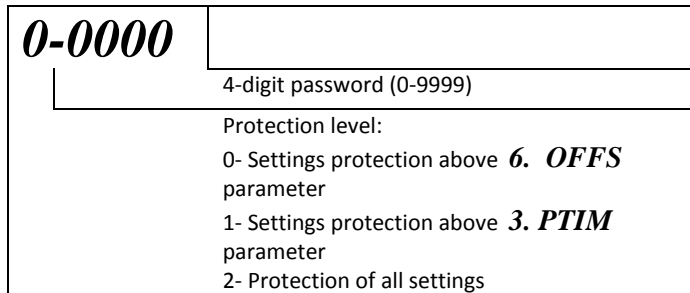

If the digital processing unit is password protected, then after switching to protected settings the display shows **0000** value – enter previously set password. The password can be deactivated by switching the parameter **19. PAS** and setting 0000 value.

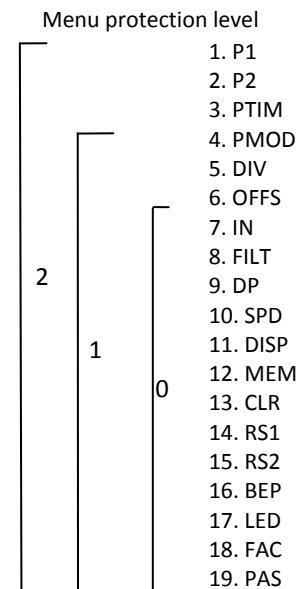

## 6. USB and RS485 Modbus interfaces

### 6.1 USB interface

USB interface is used for connection of MD150E counter with MD150E-PC software (device configuration, recording of measurements) and for updating of internal software. MD150E process display must be powered in order to facilitate connection via USB.



#### CAUTION

USB interface is prone to interference in the power supply grid and to electromagnetic interference occurring in industrial environments. In case of connection problems during communication of the digital processing unit with MD150E-PC software, apply additional protective elements in the form of:

- Powering of MD150E digital processing unit from an independent power supply source,
- Application of network filters upstream of the indicator supply feeder.
- Use of USB cable of length <1,5m equipped with ferrite beads at the cable beginning and its end.
- Use of optically insulated USB hubs at PC side.

In the conditions of severe interference (e.g. high interference of power grid) the communication may not be possible.

### 6.2 RS485 (MODBUS-RTU) interface

MD150E counter is equipped with **RS485** interface. It can be used for connection with PLC controller, HMI panel or other device supporting MODBUS-RTU protocol.

Default transmission parameters:

- Speed: **38400bps**, Bits: 8, Stop Bits: 1, parity: none
- Address **Modbus: 1**

Transmission speed and MD150E counter address in MODBUS-RTU network can be set with the following parameters:

**12. RS1** - baudrate setting MODBUS (9600, 19200, 38400, 57600, 115200)

**13. RS2** - address setting MODBUS (1...99)

## 6.2.1 Description of MODBUS protocol

### Implemented MODBUS functions

Function no (hex)	Description
1 (0x01)	Reading of outputs status (relays)
3 (0x03)	Reading X registers
5 (0x05)	Recording of single Bit

### Type of used variables

Variable name	Description	Size (Bytes)	Number of occupied registers	Range
INT	2 Bytes number with sign	2	1	-32768 - +32767
DINT	4 Bytes number with sign	4	2	$-2^{31} \dots (2^{31}-1)$
REAL	Floating point number	4	2	$1.18 \cdot 10^{-38} \dots 3.40 \cdot 10^{38}$ , 0, $-3.40 \cdot 10^{38} \dots -1.18 \cdot 10^{-38}$

### Map of MD150E records

Address	Name	Mode	Variable type (MODBUS function)	Description
0 -1 (*1-2)	COUNTER_VAL	R	DWORD (0x03)	Readout of pulses counter value (non calibrated value)
2 (*3)	CYCLE_VAL	R	INT (0x03)	Readout of cycles counter value – L
4-5 (*5-6)	COUNTER_DISP	R	REAL (0x03)	Readout of pulses counter value indicated by display (floating point number)
6-7 (*7-8)	SPEED_DISP	R	REAL (0x03)	Velocity readout indicated by display– U (floating point number)
5000 (*5001)	COUNTER_RESET	W	BYTE (0x05)	Reset of cycles and pulses counter
5002 (*5003)	PK_OUT	R	BYTE (0x01)	Readout of relay outputs status (bit 0:PK1, bit 1:PK2)
5004 (*5005)	INPUTS	R	BYTE (0x01)	Readout of inputs state (bit 0: INA, bit 1: INB, bit 2:RST)

\* for devices with address starting with 1 value (offset address +1)

CAUTION: 4-Byte number of type **REAL** or **DINT** is contained in two registries. The first registry contains younger part of the number, the second - its older part. In order to read **REAL** or **DINT** number value correctly, read two registries (X, X+1) then conduct appropriate conversion.

Conversion of 2 registries (4 Byte) into 32 Bit number (REAL, DINT)

Register HI <-> Byte1

Register LO <-> Byte0

Register\_X+1 HI <-> Byte3

Register\_X+1 LO <-> Byte2

**Number\_32\_bit** = **Byte3**<<24 + **Byte2**<<16 + **Byte1**<<8 + **Byte0**

or **Number\_32\_bit** = Register\_2 + Register\_3<<16

## Example of MODBUS communication table

Readout of counter state (non calibrated) - COUNTER\_VAL (Function: 03, Register address: 0)

Request (MODBUS MASTER -> MD150E)		Response (MD150E -> MODBUS MASTER)	
Device address	0x01	Device address	0x01
Function	<b>0x03</b>	Function	<b>0x03</b>
Hi registry address	<b>0x00</b>	Number of Bytes	0x04
Lo registry address	<b>0x00</b>	Register 0x02 Hi	REAL (Byte 1)
Number of Hi registries	0x00	Register 0x02 Lo	REAL (Byte 0)
Number of Lo registries	0x02	Register 0x03 Hi	REAL (Byte 3)
CRC Hi	0xC4	Register r 0x03 Lo	REAL (Byte 2)
CRC Lo	0x0B	CRC Hi	8 bit
		CRC Lo	8 bit

Readout of cycle counter - CYCLE\_VAL (Function: 03, Register address: 2)

Request (MODBUS MASTER -> MD150E)		Response (MD150E -> MODBUS MASTER)	
Device address	0x01	Device address	0x01
Function	<b>0x03</b>	Function	<b>0x03</b>
Hi registry address	<b>0x00</b>	Number of Bytes	0x02
Lo registry address	<b>0x02</b>	Register 0x00 Hi	INT (Byte 1)
Number of Hi registries	0x00	Register 0x00 Lo	INT (Byte0)
Number of Lo registries	<b>0x01</b>	CRC Hi	8 bit
CRC Hi	8 bit	CRC Lo	8 bit
CRC Lo	8 bit		

Counter reset- COUNTER\_RESET (Function: 05, Register address: 5000)

Request (MODBUS MASTER -> MD150E)		Response (MD150E -> MODBUS MASTER)	
Device address	0x01	Device address	0x01
Function	<b>0x05</b>	Function	<b>0x05</b>
Hi registry address	<b>0x13</b>	Address of Hi registries	<b>0x13</b>
Lo registry address	<b>0x88</b>	Address of Lo registries	<b>0x88</b>
Register 0x00 Hi	0xFF	Register 0x00 Hi	0xFF
Register 0x00 Lo	0x00	Register 0x00 Lo	0x00
CRC	16 bits	CRC	16 Bits

## 7. Technical parameters

Description	Parameter
Power supply	Standard version <b>12 ... 36V DC</b> , recommended 24 VDC, min. 250mA + current consumption MD150E-230 version: <b>85 ... 260V AC</b> , 10W, 47-440Hz
Sensor power supply output	5V DC, max. 500mA 15V DC, max. 500mA (only for 230V version, please contact with WObit technical support)
Counter inputs A/B	Differential, opt insulated Low level: 0V (max. 2V), High level: +24V (5...24V)
Reset input RST	Low level: 0V (max. 2V), High level: +24V (5...24V)
Max. frequency for counter inputs A,B	2Mhz (off-line filtration) 125Khz (filtration activated)
Min. length of reset signal RST	1ms (off-line filtration) 10ms (filtration activated)
Relay outputs PK1, PK2	2 x 1A/125VAC, 2A/30VDC
Interfaces	RS485 MODBUS-RTU, default parameters 38400bps, 8:n:1, <b>USB: 1.1, 2.0</b>
Operation temperature range	0..50° C



Display	6 digits, height 13.5 mm
Housing	Height: 45 mm Width: 92 mm Length: 81 mm
Weight	200g (300g for 230V version)
IP class	IP40, for front panel– IP65
Universal password	3145